

Article number: 206153M12KN

Description: E+G stainless steel spring plungers 615.3-M12-KN

Measures

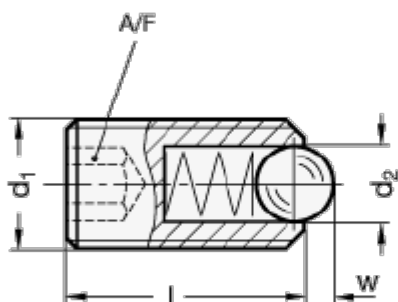

Thread locking **PFB**
Polyamide patch
for type **KN**



Thread locking **PFB**
Polyamide patch
for type **KSN**



Thread locking **MVK**
Micro encapsulation precote
(for all types)

A/F	= 6
d1	= M12
d2	= 8
l	= 26
Max. spring load in N	= 49
Preload spring pressure in N	= 26
w	= 2.5